

ACHTUNG:

Ab Juli 2023 wird die Fassung D.TNS13 (M03400-08) durch die verbesserte Ausführung (M03450-08) ersetzt. Die geänderten Pressmaße für die "neue" Fassung entnehmen Sie bitte dieser Tabelle. Bitte stellen Sie sicher, dass auch Ihre internen Pressmaßtabellen entsprechend geändert werden.

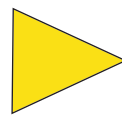
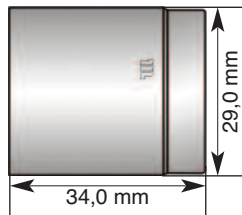

Falls Sie noch Fragen haben oder Hilfe zur Umstellung benötigen (Austausch), stehen wir gerne unterstützend zur Verfügung.

M03400-08 wird zu M03450-08

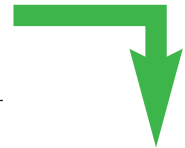
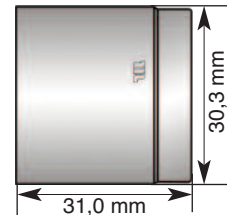

D.TNS13

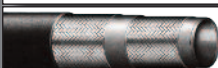

| Pressmaß ALT | Schlauchtype | Pressmaß NEU |
|--------------|--|--------------|
| 23,5 | 1SN-13 (ROCKMASTER/1SN)  | 24,0 |
| 24,3 | 2SN-13 (ROCKMASTER/2SN)  | 25,0 |
| 23,5 | 2SK-13 (ROCKMASTER/2SC)  | 24,4 |
| 24,2 | INFINITY  | 24,2 |

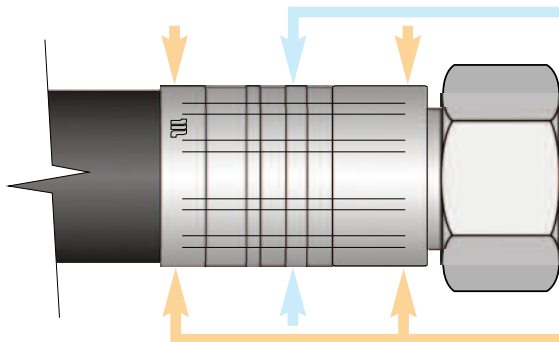

Die Pressmaßtoleranz beträgt +0,0 mm bis -0,2 mm (Messung Mitte der Fassung).

Eine konische Verpressung ist konstruktiv vorgegeben, darf aber 0,4 mm über die Gesamtlänge der Fassung nicht überschreiten (Messung am vorderen sowie am hinteren Ende der Fassung).

BITTE BEACHTEN:

Es sind immer die größtmöglichen Pressbacken zu verwenden.

HINWEIS:

DIN EN ISO 4413

Sicherheit von Maschinen - Sicherheitstechnische Anforderungen an fluidtechnische Anlagen und deren Bauteile









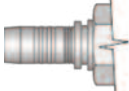

5.4.6.5 Schlauchleitungen:









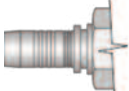

Schlauchleitungen müssen aus Schläuchen hergestellt sein, die nicht vorher als Teil einer anderen Schlauchleitung in Betrieb waren, und die alle Leistungs- und Kennzeichnungsanforderungen der zutreffenden Normen erfüllen.











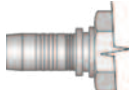













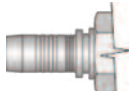



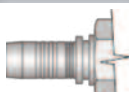

Geflechtschläuche

ACHTUNG! Geänderte Pressmaße für die neue D.TNS13 (M03450-08) Fassung

| 1SN | | ROCKMASTER/1SN | | | | Pressmaße in mm nur für manuli Schlauch und Armaturen | | | | | | | |
|---|-----------------|---|---|---|---|--|---|---|---|---|---|-------------|--|
|  | DN | 5 | 6 | 8 | 10 | 12 | 16 | 20 | 25 | 31 | 38 | 51 | |
| | Size | 03 | 04 | 05 | 06 | 08 | 10 | 12 | 16 | 20 | 24 | 32 | |
| | Zoll | 3/16" | 1/4" | 5/16" | 3/8" | 1/2" | 5/8" | 3/4" | 1" | 1 1/4" | 1 1/2" | 2" | |
| MF2000  | Fassung |  |  |  |  |  |  |  |  |  |  | | |
| | | M03400-04 D.TNS06 | M03400-05 D.TNS08 | M03400-06 D.TNS10 | M03450-08 D.TNS13 | M03400-10 D.TNS16 | M03400-12 D.TNS19 | M03400-16 D.TNS25 | M03400-20 D.TNS32 | M03400-24 D.TNS38 | M03400-32 D.TNS50 | | |
| SCHÄLFREI | Pressmaß | | 17,9 | 18,7 | 20,6 | 24,0 | 27,0 | 30,9 | 39,2 | 48,6 | 57,0 | 69,5 | |

| 2SN | | ROCKMASTER/2SN | | | | Pressmaße in mm nur für manuli Schlauch und Armaturen | | | | | | | |
|--|-----------------|--|--|--|--|---|--|--|--|--|--|-------------|--|
|  | DN | 5 | 6 | 8 | 10 | 12 | 16 | 20 | 25 | 31 | 38 | 51 | |
| | Size | 03 | 04 | 05 | 06 | 08 | 10 | 12 | 16 | 20 | 24 | 32 | |
| | Zoll | 3/16" | 1/4" | 5/16" | 3/8" | 1/2" | 5/8" | 3/4" | 1" | 1 1/4" | 1 1/2" | 2" | |
| MF2000  | Fassung |  |  |  |  |  |  |  |  |  |  | | |
| | | M03400-04 D.TNS06 | M03400-05 D.TNS08 | M03400-06 D.TNS10 | M03450-08 D.TNS13 | M03400-10 D.TNS16 | M03400-12 D.TNS19 | M03400-16 D.TNS25 | M03400-20 D.TNS32 | M03400-24 D.TNS38 | M03400-32 D.TNS50 | | |
| SCHÄLFREI | Pressmaß | | 18,6 | 19,7 | 21,4 | 25,0 | 28,1 | 31,9 | 40,0 | 50,7 | 59,6 | 72,5 | |

| 2SK | | ROCKMASTER/2SC | | | | Pressmaße in mm nur für manuli Schlauch und Armaturen | | | | | | | |
|---|-----------------|---|---|---|---|--|---|---|---|---|---|----------------------|--|
|  | DN | 5 | 6 | 8 | 10 | 12 | 16 | 20 | 25 | 31 | 38 | 51 | |
| | Size | 03 | 04 | 05 | 06 | 08 | 10 | 12 | 16 | 20 | 24 | 32 | |
| | Zoll | 3/16" | 1/4" | 5/16" | 3/8" | 1/2" | 5/8" | 3/4" | 1" | 1 1/4" | 1 1/2" | 2" | |
| MF2000  | Fassung |  |  |  |  |  |  |  |  |  |  | | |
| | | M03400-03 D.TNS04 | M03400-04 D.TNS06 | M03400-05 D.TNS08 | M03400-06 D.TNS10 | M03450-08 D.TNS13 | M03400-10 D.TNS16 | M03400-12 D.TNS19 | M03400-16 D.TNS25 | M03400-20 D.TNS32 | M03400-24 D.TNS38 | M03400-32 D.TNS50 | |
| SCHÄLFREI | Pressmaß | 16,3 | 18,2 | 19,0 | 20,6 | 24,4 | 27,4 | 31,1 | 39,4 | 48,7 | 56,2 | 69,0 | |

| 2SKS INFINITY | | INFINITY | | | | Pressmaße in mm nur für manuli Schlauch und Armaturen | | | | | | | |
|---|------------------|---|---|---|---|--|---|---|---|-----------|-----------|-----------|--|
|  | DN | 5 | 6 | 8 | 10 | 12 | 16 | 20 | 25 | 31 | 38 | 51 | |
| | Size | 03 | 04 | 05 | 06 | 08 | 10 | 12 | 16 | 20 | 24 | 32 | |
| | Zoll | 3/16" | 1/4" | 5/16" | 3/8" | 1/2" | 5/8" | 3/4" | 1" | 1 1/4" | 1 1/2" | 2" | |
| MF2000  | Fassung |  |  |  |  |  |  |  |  | | | | |
| | | M00120-04 D.TR106 | M00120-05 D.TR108 | M00120-06 D.TR110 | M00120-08 D.TR113 | M00120-10 D.TR116 | M00120-12 D.TR119 | M00130-16 D.TR125 | | | | | |
| AUSSENSCHÄLEN | Pressmaß | | 16,7 | 17,8 | 20,4 | 23,6 | 28,5 | 32,6 | 39,2 | | | | |
| | Schälmaße | | 23 | 23 | 23 | 26 | 30 | 32 | 36 | | | | |
| MF2000  | Fassung |  |  |  |  |  |  |  | | | | | |
| | | M03400-04 D.TNS06 | M03400-05 D.TNS08 | M03400-06 D.TNS10 | M03450-08 D.TNS13 | M03400-10 D.TNS16 | M03400-12 D.TNS19 | M03400-16 D.TNS25 | | | | | |
| SCHÄLFREI Druckbereich wie 2SK | Pressmaß | | 18,2 | 19,0 | 21,1 | 24,2 | 28,4 | 32,6 | 39,4 | | | | |

